

FLUSH MOUNTING JUNCTION BOXES

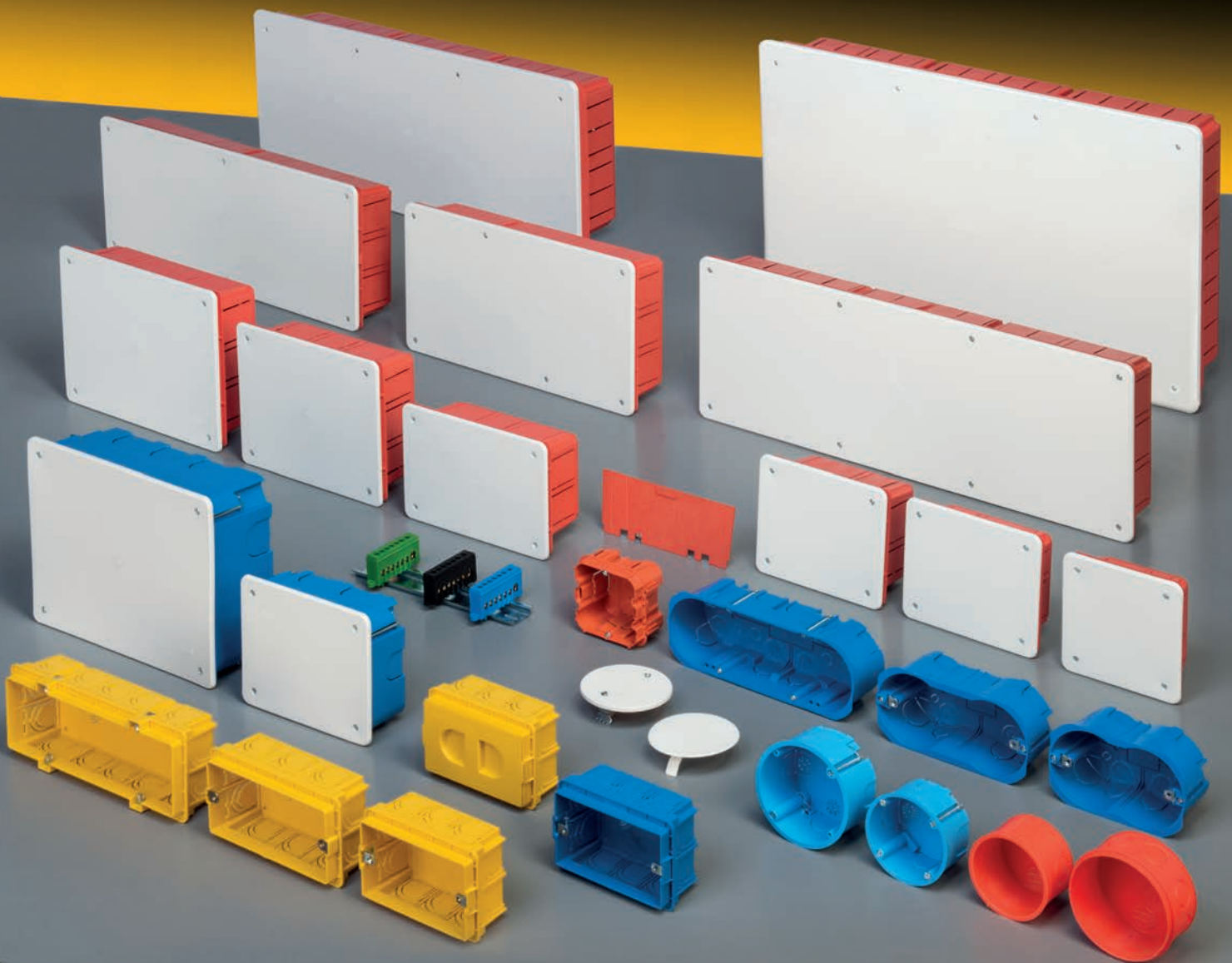

MAIN TECHNICAL FEATURES

Material: shock resistant halogen free technopolymer .

Standard colours: orange, yellow or blue for boxes, white RAL 9001 for covers.

Shock Resistance IK08 (up to 6J).

Resistance to abnormal heat (Glow Wire Test): 650° C (flush mounting).

Resistance to abnormal heat (Glow Wire Test): 850° C (dry lining walls).

Installation temperature: min. -15°C, max +60°C.

Single or multiple package with protective transparent film, packed in strong cardboard boxes.

Reference Standard: EN 60670-1:2005, EN 60670-22:2006.

Products meeting the essential requirements of L.V.D. 2014/35/UE.

Products in compliance with RoHS II - 2011/65/UE directive.



Flush mounting junction
boxes with cover
Series 350
page 304



Modular boxes big internal volume
for 3, 4, 6/7 devices
Series 371/372
page 307



Round boxes
Series 370/371
page 308



Dry lining boxes for 3, 4, 6/7
devices
Series 340
page 309



Dry lining junction boxes
Series 340
page 310

MAIN TECHNICAL FEATURES

The functional box design assures a fast and efficient installation

High-resistant white cover, easily paintable

Pre-cuttings for a quick and easy conduit inlet

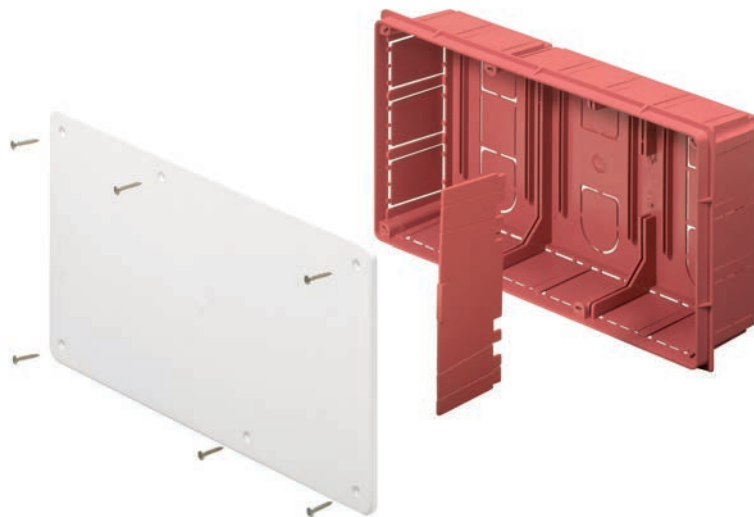

By the separator it is possible to divide the box into separate sections for different circuits

Bottom suitable for fixing the insulated brass terminal blocks

Galvanized steel screws for a stable and long cover fixing

ELETTROCANALI flush mounting junction boxes are the ideal solution for any derivation or connection in all the electrical systems made in brick or dry-lining walls both in civil and industrial applications.

The big inner volume permits to carry out the derivations of the different circuits in an adequate space, while the internal separators permit to divide the cables of the different electrical systems and to keep them separated, eliminating in this way the risk of interferences.

The junction boxes are available in 13 different dimensions fulfilling any installation needs and perfectly fitting in with any environment.

The guides in the box bottom are designed for a direct fixing of the brass terminal blocks, the Din rails EN50022 and the devices for the domotic systems.

Besides the standard device boxes, the range comprises the big volume boxes, which are particularly suitable for the domotic devices, bigger than the standard ones. They permit therefore to meet the

requirements of the new distribution systems.

The protection lids are practical, because they protect the boxes and the conduits during the building and painting works.

The high mechanical resistance assures the max. dimensional stability in any installation type.

The dry-lining boxes are suitable for inflammable walls thanks to their resistance to abnormal heat up to 850° C (Glow Wire Test according to the Standard IEC 60695-2-11).

MAIN TECHNICAL FEATURES

Quick cabling and installation thanks to the equijoint plates

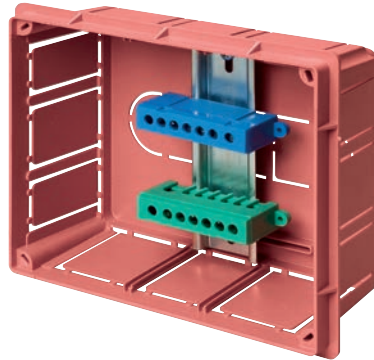

The DIN rails EN50022 can be fixed directly to the guides in the box bottom

The boxes Series 37 are ready to fix the matching spacers



The boxes can be installed in groups, whether vertically or horizontally installed. Thanks to the spacers the boxes are perfectly aligned

The boxes series 37 have matchable bottoms, with a thickness of only 10cm



The protection lids protect the boxes during the building and painting works

The flush mounting junction boxes and the modular boxes are made of shock resistant technopolymer on polystyrene base, installation temperature ranging from -15°C e $+60^{\circ}\text{C}$ and a resistance to abnormal heat up to 650°C (Glow Wire Test).

The dry-lining boxes are made of technopolymer with the same installation temperature range but with a higher resistance to abnormal heat up to 850°C , making them suitable for inflammable walls.

The screw seats permit to fix the box cover absolutely horizontally,

although the box is not perfectly flush-mounted.

The device modular boxes have threaded metallic rings for a correct fixing of the frames, firmly secured to the boxes through a special system, preventing the ring from coming out and the thread from stripping.

mounting examples





FLUSH MOUNTING JUNCTION BOX WITH LID SERIES 350

MAIN TECHNICAL FEATURES:

- Bottom made of shock resistant technopolymer, standard colour orange, blue on request.
- White (RAL 9001) cover with high impact resistance.
- Side pre-cuttings for a quick and easy conduit inlet.
- Cover fixing screws made of anticorrosive galvanized steel.
- Separator can be set in the box bottom with a simple click, in order to divide create different sections.
- Single package with protective transparent film.

CE

IP40

WHITE RAL 9001
(COVER)

ITEM	INTERNAL DIMENSIONS mm	PREPARATION FOR SECTIONS/RAILS DIN	PACKAGING PIECES
EC350C1	92x92x45	-	1/240
EC350C2	120x100x50	-	1/150
EC350C3	120x100x70	-	1/100
EC350C4	152x100x70	3 / -	1/80
EC350C5	160x130x70	3 / -	1/60
EC350C6	196x152x70	2 / -	1/40
EC350C7	294x152x70	3 / -	1/28
EC350C8	392x152x70	3 / -	1/20
EC350C9	480x160x70	3 / -	1/18
EC350C10	520x200x90	3 / 3	1/8
*EC350C11	520x295x90	6 / 3	1/6

*Internal separators included

ITEM	DESCRIPTION	PACKAGING PIECES
EC3500S	Internal separator for C4-C5-C6-C7-C8-C9	10/100
EC3510S	Internal separator for C10-C11	10
EC460C10	Rail DIN for C10-C11 (8 modules)	10

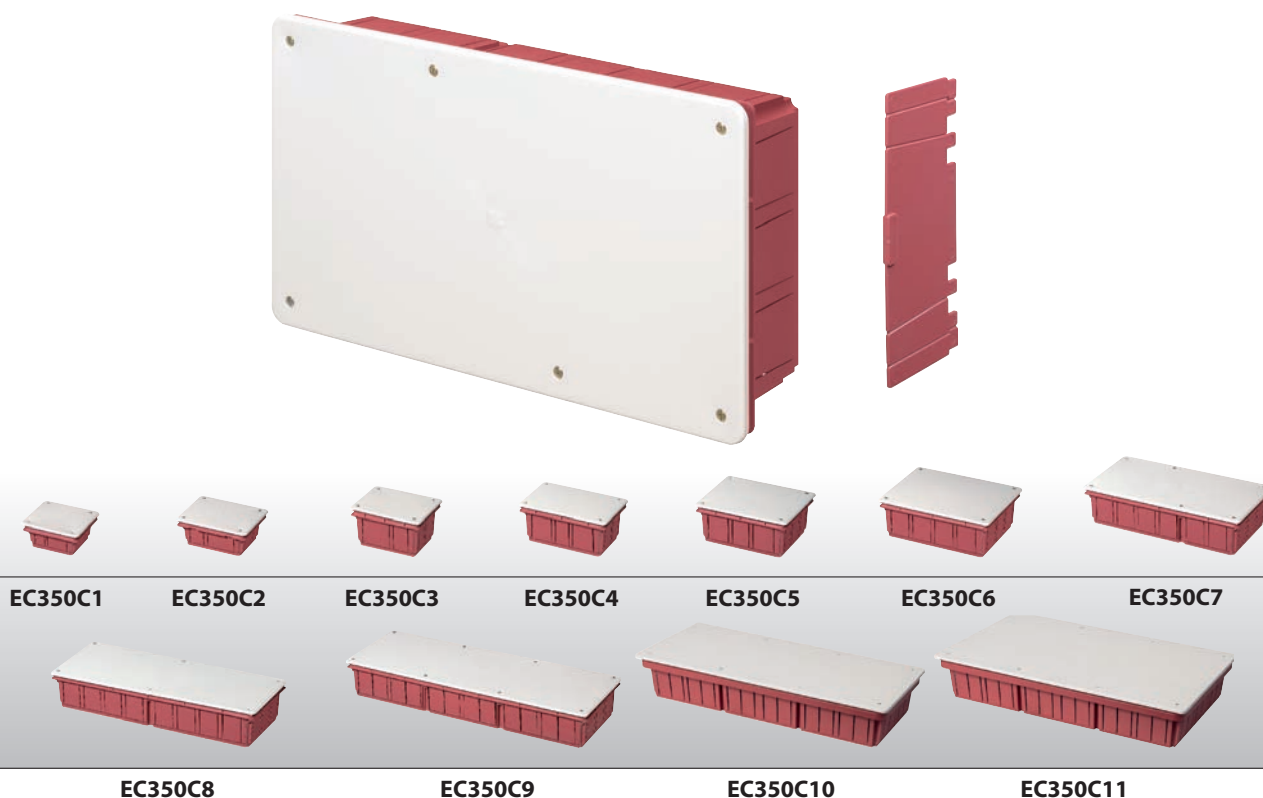

FLUSH MOUNTING JUNCTION BOX WITH COVER AND PROTECTION LID

MAIN TECHNICAL FEATURES:

- Bottom made of shock resistant technopolymer, standard colour orange, blue on request.
- White (RAL 9001) cover with high impact resistance.
- Rigid cardboard protection lid.
- Side pre-cuttings for a quick and easy conduit inlet.
- Cover fixing screws made of anticorrosive galvanized steel .
- Separator can be set in the box bottom with a simple click, in order to divide create different sections.
- Single package with protective transparent film.

IP40

WHITE RAL 9001
(COVER)

ITEM	INTERNAL DIMENSIONS mm	PREPARATION FOR SECTIONS/RAILS DIN	PACKAGING PIECES
EC350C1P	92x92x45	-	1/120
EC350C2P	120x100x50	-	1/90
EC350C3P	120x100x70	-	1/70
EC350C4P	152x100x70	3	1/80
EC350C5P	160x130x70	3	1/60
EC350C6P	196x152x70	2	1/40
EC350C7P	294x152x70	3	1/28
EC350C8P	392x152x70	3	1/20
EC350C9P	480x160x70	3	1/18

ITEM	DESCRIPTION	PACKAGING PIECES
EC3500S	Internal separator for C4-C5-C6-C7-C8-C9	10/100



SPARE COVERS FOR FLUSH MOUNTING BOXES **SERIES 351**

MAIN TECHNICAL FEATURES:

- White (RAL 9001) cover with high impact resistance.
- Cover fixing screws made of anticorrosive galvanized steel .
- Single package with protective transparent film.



ITEM	BOX DIMENSIONS mm	PACKAGING PIECES
EC351C1	C1 - 92x92	1/200
EC351C2	C2/C3 - 120x100	1/150
EC351C4	C4 - 152x100	1/120
EC351C5	C5 - 160x130	1/100
EC351C6	C6 - 196x152	1/50
EC351C7	C7 - 294x152	1/50
EC351C8	C8 - 392x152	1/50
EC351C9	C9 - 480x160	1/30
EC351C10	C10 - 520x200	1/20
EC351C11	C11 - 520x295	1/10



EC351C1



EC351C3



EC351C4



EC351C5



EC351C6



EC351C7

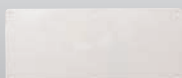

EC351C8



EC351C9

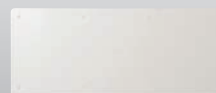

EC351C10

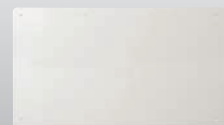

EC351C11

DEVICE-MODULAR BOXES - BIG INNER VOLUME SERIES 371/373

MAIN TECHNICAL FEATURES:

- Boxes with big inner volume: 30% more than the volume of the standard modular boxes.
- Bottom made of shock resistant technopolymer, standard colour yellow, blue on request.
- Suitable for 3,4, and 6/7 module devices.
- Product complying with the Standards: EN 60670-1:2005 + A1:2013, CEI 23-74.
- Side pre-cuttings for an easy conduit inlet, up to 25mm.
- Threaded metallic rings for a correct frame fixing.
- Protection lids can be set with a simple click.
- Spacers for a correct installation in rows of modular boxes, vertically or horizontally installed.



Devices modular boxes - big inner volume

ITEM	HOLE CENTRE DISTANCE mm	MAX DEVICE NUMBER	INTERNAL DIMENSIONS mm	PACKAGING PIECES
EC37100	83,5	3	95x70x48	10/400
EC37104	108,5	4	118x70x48	10/240
EC37106	100	6/7	178x70x48	10/150

Accessories – protection lids

ITEM	DESCRIPTION	DIMENSIONS mm	PACKAGING PIECES
EC37110	Protection lid 3 modules	97x60	10/400
EC37111	Spacer for EC37100/104/106	40	20/200

60x60 standard modular box for device

ITEM	HOLE CENTRE DISTANCE mm	MAX DEVICE NUMBER	DIMENSIONS mm	PACKAGING PIECES
EC37301	60	2	63x63x40	300

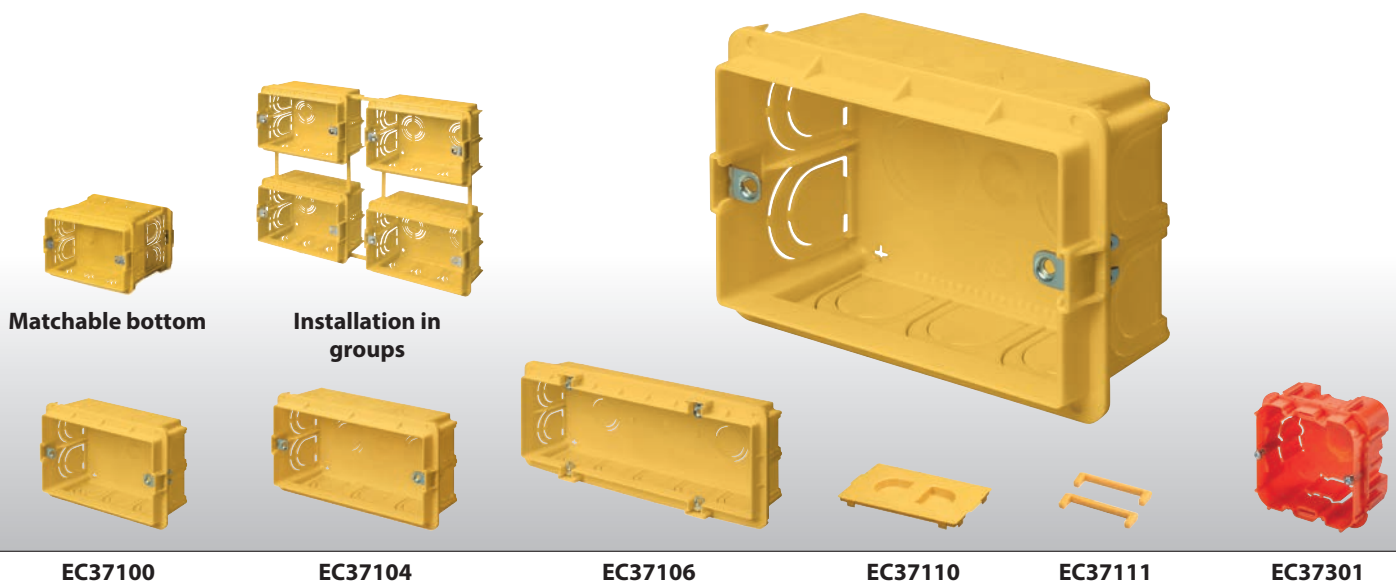

FLUSH MOUNTING ROUND BOXES **SERIES 370**

MAIN TECHNICAL FEATURES::

- Made of shock resistant technopolymer colour orange.
- Resistance to abnormal heat: up to 650°C (Glow Wire Test Standard IEC 60695-2-11).
- Side pre-cuttings for an easy conduit inlet.
- Inner box edge with cover sealing system.
- Cover fixing screws made of anticorrosive galvanized steel .

CE

WHITE RAL 9001
(COVER)

ITEM	DESCRIPTION DIMENSIONS	PACKAGING PIECES
EC37065	Round junction box Ø 60 x 40 mm	10/600
EC37085	Round junction box Ø 80 x 40 mm	10/400
EC37160	Snap-on cover Ø 60 mm	50/2000
EC37180	Snap-on cover Ø 80 mm	50/1200
EC37165	Screw cover with brackets Ø 60 mm	50/800
EC37185	Screw cover with brackets Ø 80 mm	50/600



EC37065



EC37085



EC37160



EC37180



EC37165



EC37185

■ DRY LINING INSTALLATION BOXES (HOLLOW WALLS) SERIES 340

MAIN TECHNICAL FEATURES:

- Made of shock resistance technopolymer colour blue.
- Resistance to abnormal heat: up to 850°C (Glow Wire Test Standard: IEC 60695-2-11).
- Suitable for installation of 3, 4, 6/7 module devices or devices with hole centre distance 60 mm.
- Product complying with the Standard EN 60670-1:2005.
- Box bottom with installation drilling holes 68 mm.
- Anticorrosive galvanized steel fixing screws and rings.
- Threaded metallic rings for a better fixing of the 3 and 4 module frames.
- Hollow wall installation (plasterboard or wooden wall).



■ Dry lining installation boxes-modular devices

ITEM	DESCRIPTION DIMENSIONS	PACKAGING PIECES
EC34003	Modular box - hole centre distance 83,5 mm - 3 devices	10/300
EC34004	Modular box - hole centre distance 108,5 mm - 4 devices	10/230
EC34006	Modular box - hole centre distance 100 mm - 6/7 devices	10/160
EC34040	Modular box - hole centre distance 60mm - Ø 68x40 mm	10/550



EC34003



EC34004

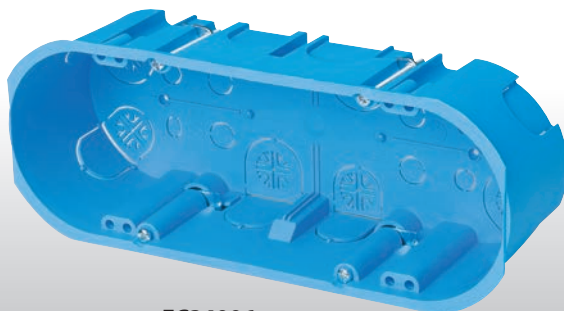

EC34006



EC34040

■ DRY LINING INSTALLATION BOXES (HOLLOW WALLS) SERIES 340

MAIN TECHNICAL FEATURES:

- Made of shock resistance technopolymer colour blue.
- Resistance to abnormal heat: up to 850°C (Glow Wire Test Standard: IEC 60695-2-11).
- Product complying with the Standard: EN 60670-1:2005, EN 60670-22:2006.
- Box bottom with installation drilling holes 68 mm .
- Anticorrosive galvanized steel fixing screws and rings.
- Hollow wall installation (plasterboard or wooden wall).



■ Dry lining installation junction boxes

ITEM	DESCRIPTION INTERNAL DIMENSIONS mm	PACKAGING PIECES
EC340105	Junction box with cover dim. 120x100x50 Screw cover	1/150
EC340106	Junction box with cover dim. 200x150x75 Screw cover	1/40
EC34045	Round junction box Ø 80x45 mm Cover not supplied	10/350

■ Spare covers for dry lining installation junction boxes

ITEM	DESCRIPTION DIMENSIONS	PACKAGING PIECES
EC351C3	Spare cover dim. 120x100 for 340105	1/150
EC351C6	Spare cover dim. 200x150 for 340106	1/50
EC37180	Snap-on cover Ø 80 mm for 34045	50/1200
EC37185	Screw cover with brackets Ø 80 mm for 34045	50/600

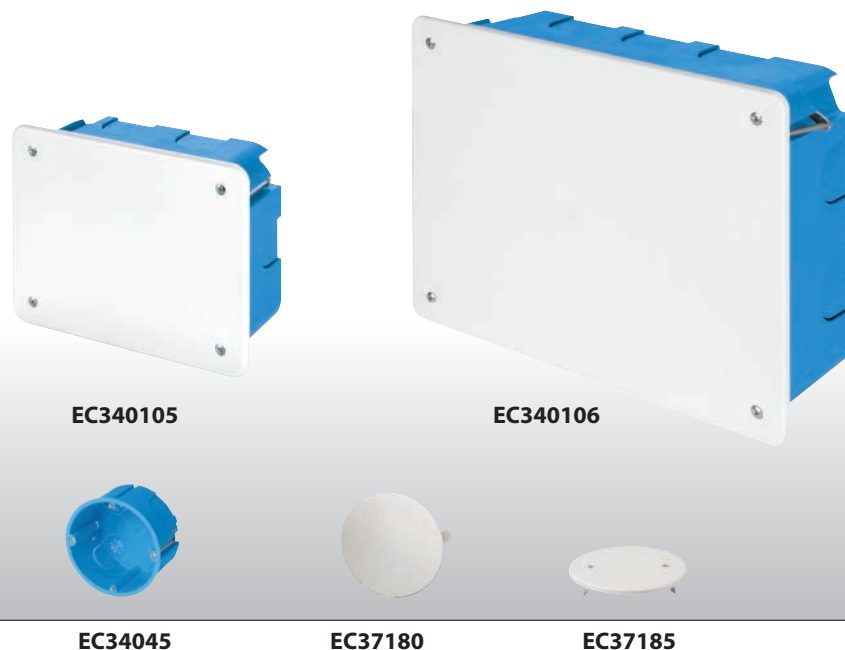

INSULATED BRASS TERMINAL BLOCKS AND DIN RAILS EN 50022 **SERIES 890/460**

MAIN TECHNICAL FEATURES:

- Insulated brass terminal blocks per earth, neutral and phase connection.
- Insulated brass terminal to be set with a simple click on DIN EN 50022 rail or directly in the bottom boxes.
- Supplied with mounted galvanized steel screws.
- Series 890: made in self-extinguishing PA6.6.
- Anticorrosive galvanized steel din rails DIN EN 50022 .
- DIN RAIL in perforated version available on request.
- To be installed in the bottom guides of the flush mounting boxes in horizontal or vertical position.



Insulated brass terminal blocks to be set on DIN RAIL EN 50022

ITEM	HOLES AND SECTION mm ²	COLOUR	PACKAGING PIECES
EC890050	Section 1x35 - 6x16		10/340
EC890051	Section 1x35 - 1x25 - 10x16		10/320
EC890052	Section 1x35 - 2x25 - 12x16		10/240
EC890053	Section 1x35 - 6x16		10/340
EC890054	Section 1x35 - 1x25 - 10x16		10/320
EC890055	Section 1x35 - 2x25 - 12x16		10/240
EC890056	Section 1x35 - 6x16		10/340
EC890057	Section 1x35 - 1x25 - 10x16		10/320
EC890058	Section 1x35 - 2x25 - 12x16		10/240

DIN EN 50022 RAILS

ITEM	LENGTH mt	DESCRIPTION TYPE	DIMENSIONS mm	PACKAGING PIECES
EC460	2	BLANK DIN RAIL	35x7,5x1	20
EC460F	2	PERFORATED DIN	35x7,5x1	20
EC46015	2	BLANK DIN RAIL	35x15x1,5	10

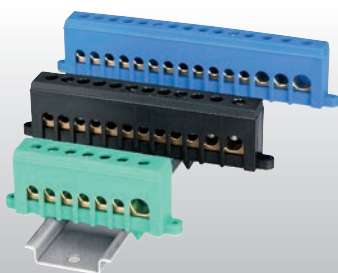

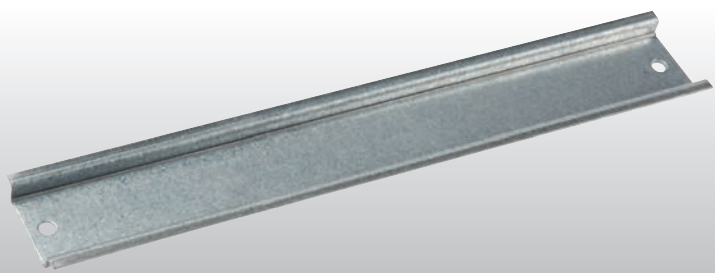

EC890









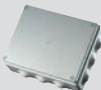



EC460D

CHOICE TABLE FOR WALL MOUNTING JUNCTION BOXES

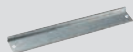
IP44		DIMENSIONS mm		
MODEL	DESCRIPTION	Ø65x35	Ø80x40	80x80x40
	THERMORESISTANT GWT 650° C	EC400C1	EC400C2	EC400C3 EC410C3
	SELF-EXTINGUISHING GWT 960° C	EC400C1A	EC400C2A	EC400C3A

IP55		DIMENSIONS mm							
MODEL	DESCRIPTION	100x100x50	120x80x50	150x110x70	190x140x70	240x190x90	300x220x120	380x300x120	460x380x120
	THERMORESISTANT GWT 650° C	EC400C4	EC400C4R	EC400C5	EC400C6	EC400C7	EC400C8	EC400C9	EC400C10
	SELF-EXTINGUISHING GWT 960° C	EC400C4A	EC400C4RA	EC400C5A	EC400C6A	EC400C7A	EC400C8A	EC400C9A	EC400C10A

IP56		DIMENSIONS mm							
MODEL	DESCRIPTION	100x100x50	120x80x50	150x110x70	190x140x70	240x190x90	300x220x120	380x300x120	460x380x120
	THERMORESISTANT GWT 650° C	EC410C4	EC410C4R	EC410C5	EC410C6	EC410C7	EC410C8	EC410C9	EC410C10
	SELF-EXTINGUISHING GWT 960° C	EC410C4A	EC410C4RA	EC410C5A	EC410C6A	EC410C7A	EC410C8A	EC410C9A	EC410C10A
	THERMORESISTANT GWT 650° C	-	-	EC420C5	EC420C6	EC420C7	EC420C8	EC420C9	EC420C10
	POLYCARBONATE GWT 650° C	EC480C4	EC480C4R	EC480C5	EC480C6	EC480C7	EC480C8	EC480C9	EC480C10
				150x110x140	190x140x140	240x190x160	300x220x180	380x300x180	
	THERMORESISTANT GWT 650° C	-	-	EC430C5	EC430C6	EC430C7	EC430C8	EC430C9	-
	THERMORESISTANT GWT 650° C	-	-	EC440C5	EC440C6	EC440C7	EC440C8	EC440C9	-
	POLYCARBONATE GWT 650° C	-	-	EC490C5	EC490C6	EC490C7	EC490C8	EC490C9	-
	METAL BACK PLATE	-	-	-	EC450P6	EC450P7	EC450P8	EC450P9	EC450P10
	INSULANTING BACK PLATE	-	-	-	EC451P6	EC451P7	EC451P8	EC451P9	EC451P10
	DIN RAIL EN 50022	-	-	EC460D5	EC460D6	EC460D7	EC460D8	EC460D9	EC460D10

IP66		DIMENSIONS mm							
MODEL	DESCRIPTION	90x90x53	128x103x55	154x129x58	178x155x74	239x202x85	294x244x114	392x298x144	
	ALUMINIUM BOXES	EC485C1	EC485C2	EC485C3	EC485C4	EC485C5	EC485C6	EC485C7 (IP55)	-
	METAL BACK PLATE	-	EC455P2	EC455P3	EC455P4	EC455P5	EC455P6	EC455P7	-
	DIN RAIL EN 50022	EC465D1	EC465D2	EC465D3	EC465D4	EC465D5	EC465D6	EC465D7	-

CHOICE TABLE FOR WALL MOUNTING JUNCTION BOXES

IP55		DIMENSIONS mm	
MODEL	DESCRIPTION	105x105x55	155x110x70
	THERMORESISTANT JUNCTION BOXES WITH CABLE DIRECT INLET - GWT 650° C	EC401C4	EC401C5
	SEFL-EXTINGUISHING JUNCTION BOXES WITH CABLE DIRECT INLET GWT - 960° C	EC401C4A	EC401C5A
	THERMORESISTANT JUNCTION BOXES WITH STEPPED GLANDS GWT 650° C	EC405C4	EC405C5
	SEFL-EXTINGUISHING JUNCTION BOXES WITH STEPPED GLANDS - GWT 960° C	EC405C4A	EC405C5A
	SEFL-EXTINGUISHING JUNCTION BOXES WITH CABLE DIRECT INLET - GWT 960° C	EC407C4A	EC407C5A
	SEFL-EXTINGUISHING JUNCTION BOXES WITH STEPPED GLANDS GWT 960° C	EC406C4A	EC406C5A
IP56		DIMENSIONS mm	
MODEL	DESCRIPTION	105x105x55	155x110x70
	THERMORESISTANT GWT 650° C	EC415C4	EC415C5
	SEFL-EXTINGUISHING GWT 960° C	EC415C4A	EC415C5A
	SEFL-EXTINGUISHING GWT 960° C	EC416C4A	EC416C5A

CHOICE TABLE FOR DEVICE WALL BOXES



MODEL	DESCRIPTION	DEVICE NR.						
		1 DEVICE	2 DEVICES	3 DEVICES	4 DEVICES	6 DEVICES	4 DEVICES (2+2 VERT.)	6 DEVICES (3+3 VERT.)
	BOXES IP40	EC300A1	EC300A2	EC300A3	EC300A4	EC300A6	EC300A4V	EC300A6V
	BOXES IP55	EC310A1	EC310A2	EC310A3	EC310A4	-	EC310A4V	EC310A6V

CHOICE TABLE FOR FLUSH MOUNTING JUNCTION BOXES

		DIMENSIONS mm										
MODEL	DESCRIPTION	92x92x45	120x100x50	120x100x70	152x100x70	160x130x70	196x152x70	294x152x70	392x152x70	480x160x70	520x200x90	520x295x90
	BOXES serie 350	EC350C1	EC350C2	EC350C3	EC350C4	EC350C5	EC350C6	EC350C7	EC350C8	EC350C9	EC350C10	EC350C11
	COVERS serie 351	EC351C1	EC351C3	EC351C3	EC351C4	EC351C5	EC351C6	EC351C7	EC351C8	EC351C9	EC351C10	EC351C11